

Design of Synchronous Machines

Introduction

Synchronous machines are AC machines that have a field circuit supplied by an external DC source. Synchronous machines are having two major parts namely stationary part stator and a rotating field system called rotor.

In a synchronous generator, a DC current is applied to the rotor winding producing a rotor magnetic field. The rotor is then driven by external means producing a rotating magnetic field, which induces a 3-phase voltage within the stator winding.

Field windings are the windings producing the main magnetic field (rotor windings for synchronous machines); armature windings are the windings where the main voltage is induced (stator windings for synchronous machines).

Types of synchronous machines

1. Hydrogenerators : The generators which are driven by hydraulic turbines are called hydrogenerators. These are run at lower speeds less than 1000 rpm.
2. Turbogenerators: These are the generators driven by steam turbines. These generators are run at very high speed of 1500rpm or above.
3. Engine driven Generators: These are driven by IC engines. These are run at aspeed less than 1500 rpm.

Hence the prime movers for the synchronous generators are Hydraulic turbines, Steam turbines or IC engines.

Hydraulic Turbines: Pelton wheel Turbines: Water head 400 m and above

Francis turbines: Water heads up to 380 m

Keplan Turbines: Water heads up to 50 m

Steam turbines: The synchronous generators run by steam turbines are called turbogenerators or turbo alternators. Steam turbines are to be run at very high speed to get higher efficiency and hence these types of generators are run at higher speeds.

Diesel Engines: IC engines are used as prime movers for very small rated generators.

Construction of synchronous machines

1. Salient pole Machines: These type of machines have salient pole or projecting poles with concentrated field windings. This type of construction is for the machines which are driven by hydraulic turbines or Diesel engines.
 2. Nonsalient pole or Cylindrical rotor or Round rotor Machines: These machines are having cylindrical smooth rotor construction with distributed field winding in slots. This type of rotor construction is employed for the machine driven by steam turbines.
1. Construction of Hydro-generators: These types of machines are constructed based on the water head available and hence these machines are low speed machines. These machines are constructed based on the mechanical consideration. For the given frequency the low speed demands large number of poles and consequently large

diameter. The machine should be so connected such that it permits the machine to be transported to the site. It is a normal to practice to design the rotor to withstand the centrifugal force and stress produced at twice the normal operating speed.

Stator core:

The stator is the outer stationary part of the machine, which consists of

- The outer cylindrical frame called yoke, which is made either of welded sheet steel, cast iron.
- The magnetic path, which comprises a set of slotted steel laminations called stator core pressed into the cylindrical space inside the outer frame. The magnetic path is laminated to reduce eddy currents, reducing losses and heating. CRGO laminations of 0.5 mm thickness are used to reduce the iron losses.

A set of insulated electrical windings are placed inside the slots of the laminated stator. The cross-sectional area of these windings must be large enough for the power rating of the machine. For a 3-phase generator, 3 sets of windings are required, one for each phase connected in star. Fig. 1 shows one stator lamination of a synchronous generator. In case of generators where the diameter is too large stator lamination can not be punched in on circular piece. In such cases the laminations are punched in segments. A number of segments are assembled together to form one circular laminations. All the laminations are insulated from each other by a thin layer of varnish.

Details of construction of stator are shown in Figs 2 -

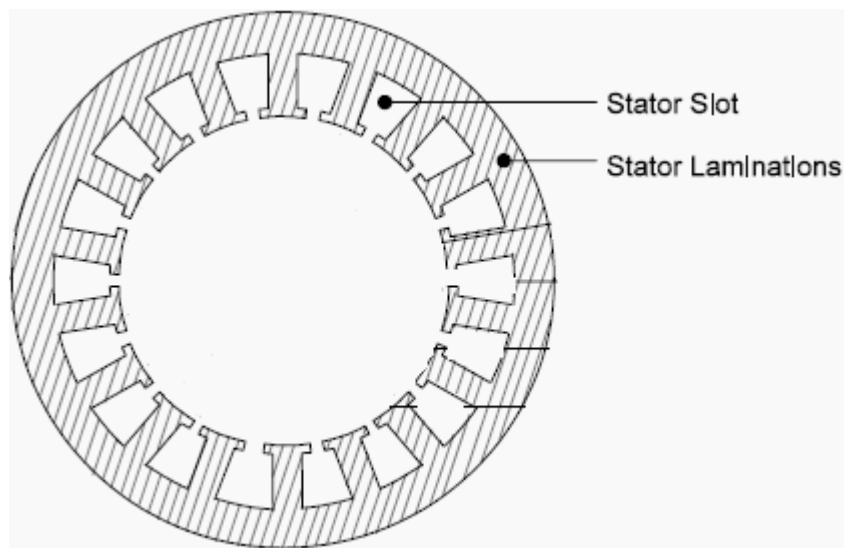

Fig. 1. Stator lamination

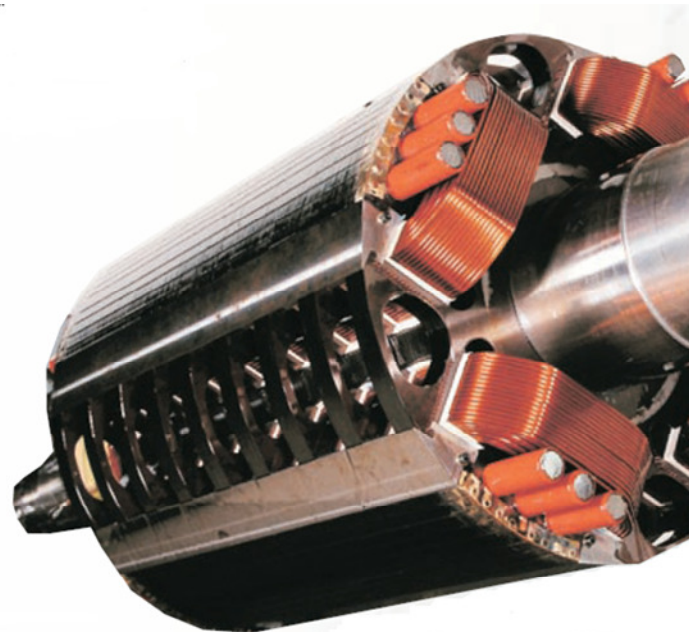
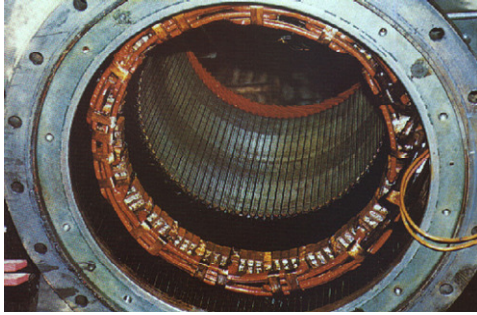

Fig 2. (a) Stator and (b) rotor of a salient pole alternator



Fig 3. (a) Stator of a salient pole alternator

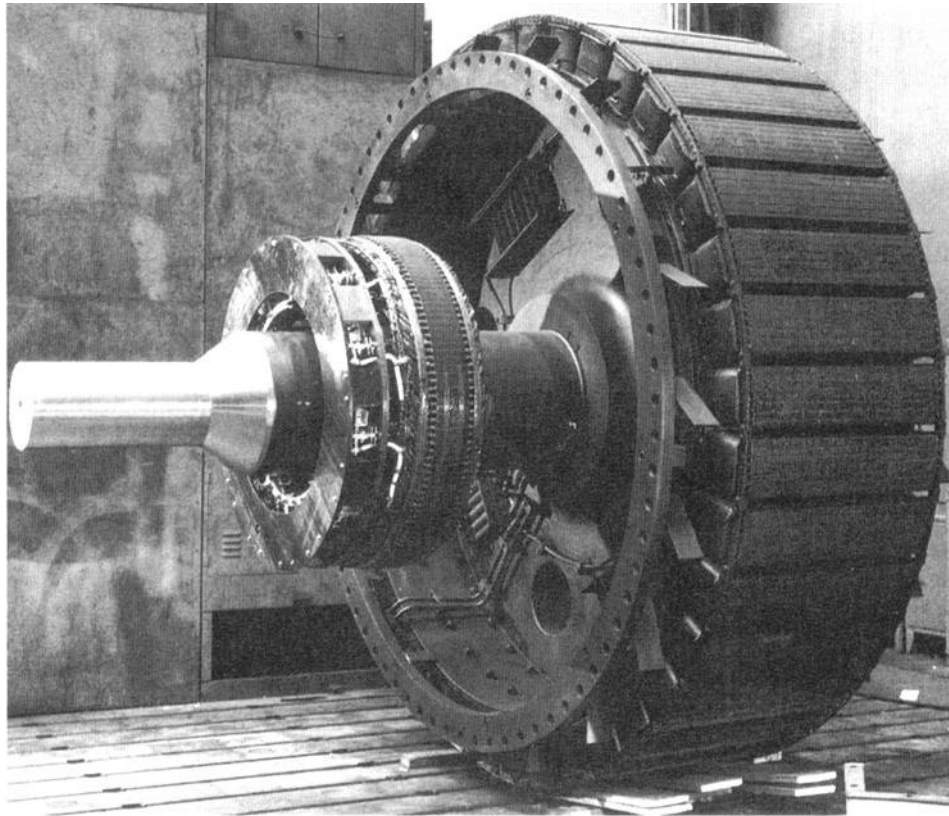
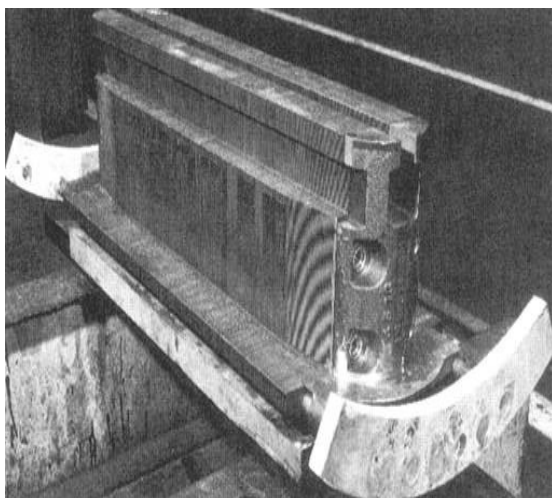
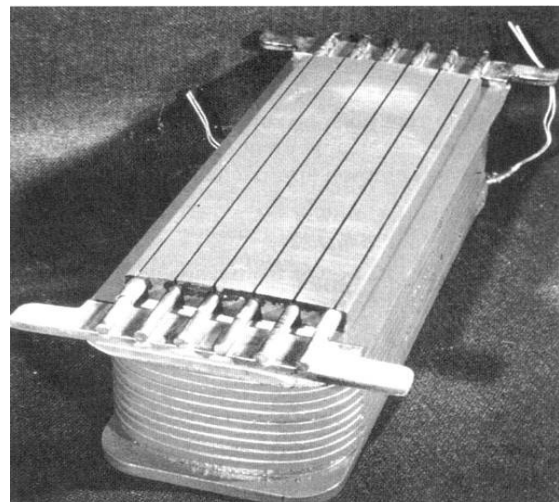

Fig 4. Rotor of a salient pole alternator



(a)



(b)

Fig 5. (a) Pole body (b) Pole with field coils of a salient pole alternator

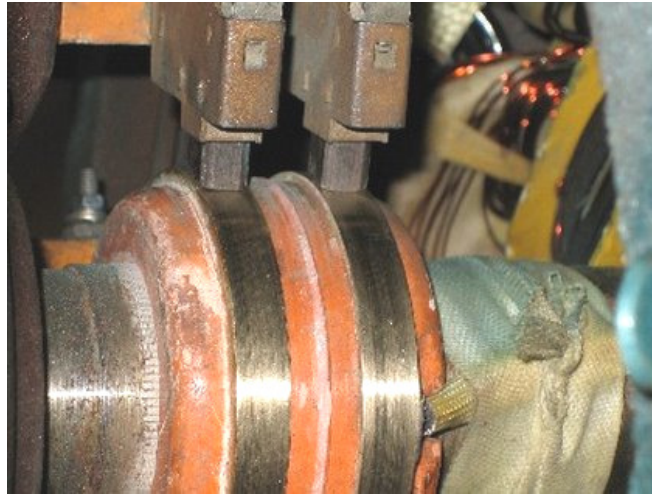

Fig 6. Slip ring and Brushes

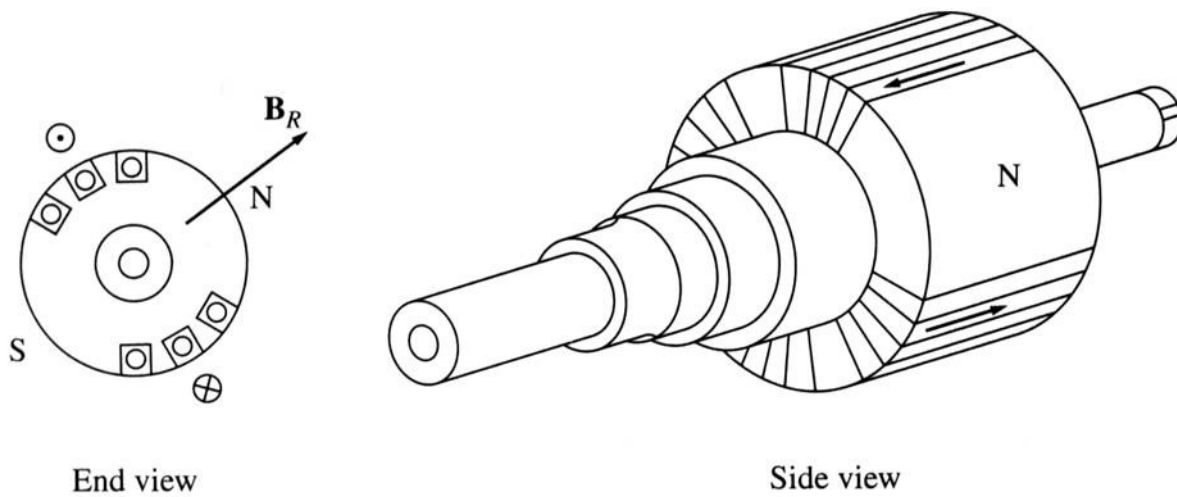

Fig 7. Rotor of a Non salient pole alternator

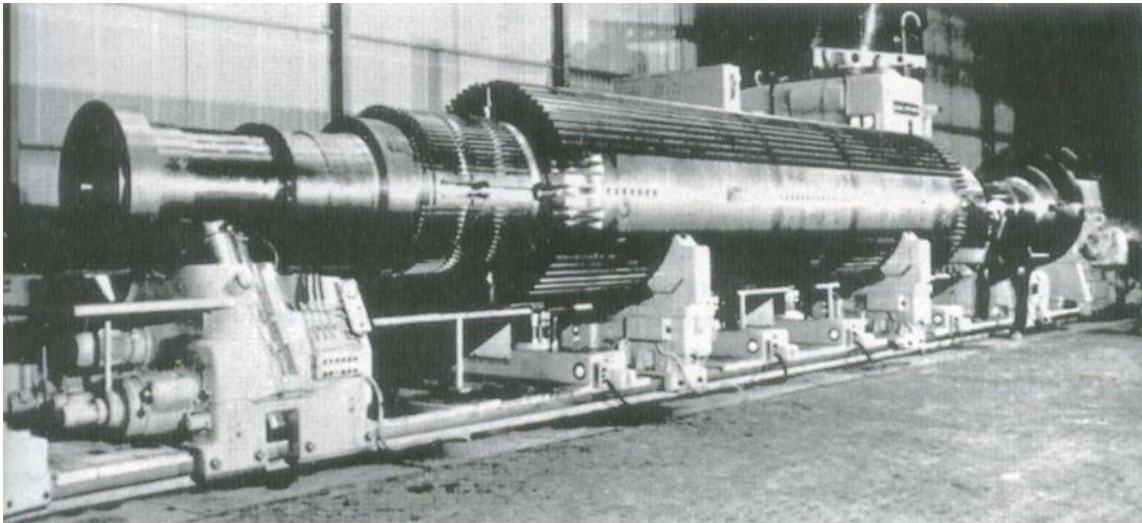
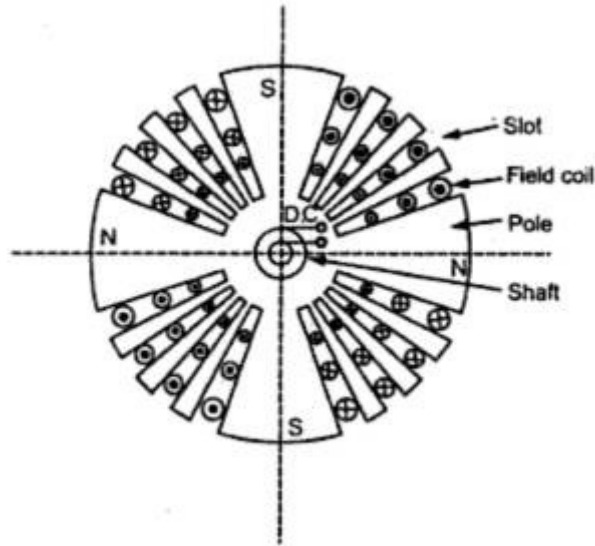

Fig 8. Rotor of a Non salient pole alternator

Rotor of water wheel generator consists of salient poles. Poles are built with thin silicon steel laminations of 0.5mm to 0.8 mm thickness to reduce eddy current laminations. The laminations are clamped by heavy end plates and secured by studs or rivets. For low speed rotors poles have the bolted on construction for the machines with little higher peripheral speed poles have dove tailed construction as shown in Figs. Generally rectangular or round pole constructions are used for such type of alternators. However the round poles have the advantages over rectangular poles.

Generators driven by water wheel turbines are of either horizontal or vertical shaft type. Generators with fairly higher speeds are built with horizontal shaft and the generators with higher power ratings and low speeds are built with vertical shaft design. Vertical shaft generators are of two types of designs (i) Umbrella type where in the bearing is mounted below the rotor. (ii) Suspended type where in the bearing is mounted above the rotor.

In case of turbo alternator the rotors are manufactured from solid steel forging. The rotor is slotted to accommodate the field winding. Normally two third of the rotor periphery is slotted to accommodate the winding and the remaining one third unslotted portion acts as the pole. Rectangular slots with tapering teeth are milled in the rotor. Generally rectangular aluminum or copper strips are employed for field windings. The field windings and the overhangs of the field windings are secured in place by steel retaining rings to protect against high centrifugal forces. Hard composition insulation materials are used in the slots which can withstand high forces, stresses and temperatures. Perfect balancing of the rotor is done for such type of rotors.

Damper windings are provided in the pole faces of salient pole alternators. Damper windings are nothing but the copper or aluminum bars housed in the slots of the pole faces. The ends of the damper bars are short circuited at the ends by short circuiting rings similar to end rings as in the case of squirrel cage rotors. These damper windings are serving the function of providing mechanical balance; provide damping effect, reduce the effect of over voltages and damp out hunting in case of alternators. In case of synchronous motors they act as rotor bars and help in self starting of the motor.

Relative dimensions of Turbo and water wheel alternators:

Turbo alternators are normally designed with two poles with a speed of 3000 rpm for a 50 Hz frequency. Hence peripheral speed is very high. As the diameter is proportional to the peripheral speed, the diameter of the high speed machines has to be kept low. For a given volume of the machine when the diameter is kept low the axial length of the machine increases. Hence a turbo alternator will have small diameter and large axial length.

However in case of water wheel generators the speed will be low and hence number of poles required will be large. This will indirectly increase the diameter of the machine. Hence for a given volume of the machine the length of the machine reduces. Hence the water wheel generators will have large diameter and small axial length in contrast to turbo alternators.

Introduction to Design

Synchronous machines are designed to obtain the following informations.

- (i) Main dimensions of the stator frame.
- (ii) Complete details of the stator windings.
- (iii) Design details of the rotor and rotor winding.
- (iv) Performance details of the machine.

To proceed with the design and arrive at the design information the design engineer needs the following information.

- (i) Specifications of the synchronous machine.
- (ii) Information regarding the choice of design parameters.
- (iii) Knowledge on the availability of the materials.
- (iv) Limiting values of performance parameters.
- (v) Details of Design equations.

Specifications of the synchronous machine:

Important specifications required to initiate the design procedure are as follows:

Rated output of the machine in kVA or MVA, Rated voltage of the machine in kV, Speed, frequency, type of the machine generator or motor, Type of rotor salient pole or non salient pole, connection of stator winding, limit of temperature, details of prime mover etc.

Main Dimensions:

Internal diameter and gross length of the stator forms the main dimensions of the machine. In order to obtain the main dimensions it is required to develop the relation between the output and the main dimensions of the machine. This relation is known as the output equation.

Output Equation:

Output of the 3 phase synchronous generator is given by

$$\text{Output of the machine } Q = 3V_{ph} I_{ph} \times 10^{-3} \text{ kVA}$$

Assuming Induced emf $E_{ph} = V_{ph}$

$$\text{Output of the machine } Q = 3E_{ph} I_{ph} \times 10^{-3} \text{ kVA}$$

$$\begin{aligned} \text{Induced emf } E_{ph} &= 4.44 f \Phi T_{ph} K_w \\ &= 2.22 f \Phi Z_{ph} K_w \end{aligned}$$

Frequency of generated emf $f = PN_s/120 = Pn_s/2,$

Air gap flux per pole $\Phi = B_{av}\pi DL/p,$ and Specific electric loading $q = 3I_{ph} Z_{ph}/ \pi D$

$$\text{Output of the machine } Q = 3 \times (2.22 \times Pn_s/2 \times B_{av}\pi DL/p \times Z_{ph} \times K_w) I_{ph} \times 10^{-3} \text{ kVA}$$

$$\text{Output } Q = (1.11 \times B_{av}\pi DL \times n_s \times K_w) (3 \times I_{ph} Z_{ph}) \times 10^{-3} \text{ kVA}$$

Substituting the expressions for Specific electric loadings

$$\text{Output } Q = (1.11 \times B_{av}\pi DL \times n_s \times K_w) (\pi D q) \times 10^{-3} \text{ kVA}$$

$$Q = (1.11 \pi^2 D^2 L B_{av} q K_w n_s \times 10^{-3}) \text{ kVA}$$

$$Q = (11 B_{av} q K_w \times 10^{-3}) D^2 L n_s \text{ kVA}$$

Therefore Output $Q = C_o D^2 L n_s \text{ kVA}$

$$\text{or } D^2 L = Q/ C_o n_s \text{ m}^3$$

where $C_o = (11 B_{av} q K_w \times 10^{-3})$

V_{ph} = phase voltage ; I_{ph} = phase current E_{ph} = induced emf per phase

Z_{ph} = no of conductors/phase in stator

T_{ph} = no of turns/phase

N_s = Synchronous speed in rpm

n_s = synchronous speed in rps

p = no of poles, q = Specific electric loading

Φ = air gap flux/pole; B_{av} = Average flux density

k_w = winding factor

From the output equation of the machine it can be seen that the volume of the machine is directly proportional to the output of the machine and inversely proportional to the speed of the machine. The machines having higher speed will have reduced size and cost. Larger values of specific loadings smaller will be the size of the machine.

Choice of Specific loadings: From the output equation it is seen that choice of higher value of specific magnetic and electric loading leads to reduced cost and size of the machine.

Specific magnetic loading: Following are the factors which influences the performance of the machine.

- (i) Iron loss: A high value of flux density in the air gap leads to higher value of flux in the iron parts of the machine which results in increased iron losses and reduced efficiency.
- (ii) Voltage: When the machine is designed for higher voltage space occupied by the insulation becomes more thus making the teeth smaller and hence higher flux density in teeth and core.
- (iii) Transient short circuit current: A high value of gap density results in decrease in leakage reactance and hence increased value of armature current under short circuit conditions.
- (iv) Stability: The maximum power output of a machine under steady state condition is indirectly proportional to synchronous reactance. If higher value of flux density is used it leads to smaller number of turns per phase in armature winding. This results in reduced value of leakage reactance and hence increased value of power and hence increased steady state stability.
- (v) Parallel operation: The satisfactory parallel operation of synchronous generators depends on the synchronizing power. Higher the synchronizing power higher will be the ability of the machine to operate in synchronism. The synchronizing power is inversely proportional to the synchronous reactance and hence the machines designed with higher value air gap flux density will have better ability to operate in parallel with other machines.

Specific Electric Loading: Following are the some of the factors which influence the choice of specific electric loadings.

- (i) Copper loss: Higher the value of q larger will be the number of armature of conductors which results in higher copper loss. This will result in higher temperature rise and reduction in efficiency.

- (ii) Voltage: A higher value of q can be used for low voltage machines since the space required for the insulation will be smaller.
 - (iii) Synchronous reactance: High value of q leads to higher value of leakage reactance and armature reaction and hence higher value of synchronous reactance. Such machines will have poor voltage regulation, lower value of current under short circuit condition and low value of steady state stability limit and small value of synchronizing power.
 - (iv) Stray load losses: With increase of q stray load losses will increase.
- Values of specific magnetic and specific electric loading can be selected from Design Data Hand Book for salient and nonsalient pole machines.

Separation of D and L: Inner diameter and gross length of the stator can be calculated from D^2L product obtained from the output equation. To separate suitable relations are assumed between D and L depending upon the type of the generator.

Salient pole machines: In case of salient pole machines either round or rectangular pole construction is employed. In these types of machines the diameter of the machine will be quite larger than the axial length.

Round Poles: The ratio of pole arc to pole pitch may be assumed varying between 0.6 to 0.7 and pole arc may be taken as approximately equal to axial length of the stator core. Hence

$$\text{Axial length of the core/ pole pitch} = L/\tau_p = 0.6 \text{ to } 0.7$$

Rectangular poles: The ratio of axial length to pole pitch may be assumed varying between 0.8 to 3 and a suitable value may be assumed based on the design specifications.

$$\text{Axial length of the core/ pole pitch} = L/\tau_p = 0.8 \text{ to } 3$$

Using the above relations D and L can be separated. However once these values are obtained diameter of the machine must satisfy the limiting value of peripheral speed so that the rotor can withstand centrifugal forces produced. Limiting values of peripheral speeds are as follows:

Bolted pole construction = 45 m/s

Dove tail pole construction = 75 m/s

Normal design = 30 m/s

Turbo alternators: These alternators will have larger speed of the order of 3000 rpm. Hence the diameter of the machine will be smaller than the axial length. As such the diameter of the rotor is limited from the consideration of permissible peripheral speed limit. Hence the internal diameter of the stator is normally calculated based on peripheral speed. The peripheral speed in case of turbo alternators is much higher than the salient pole machines. Peripheral speed for these alternators must be below 175 m/s.

Short Circuit Ratio:

It is defined as the ratio of field current required to produce rated voltage on open circuit to the field current reqd. to circulate rated current on short circuit.

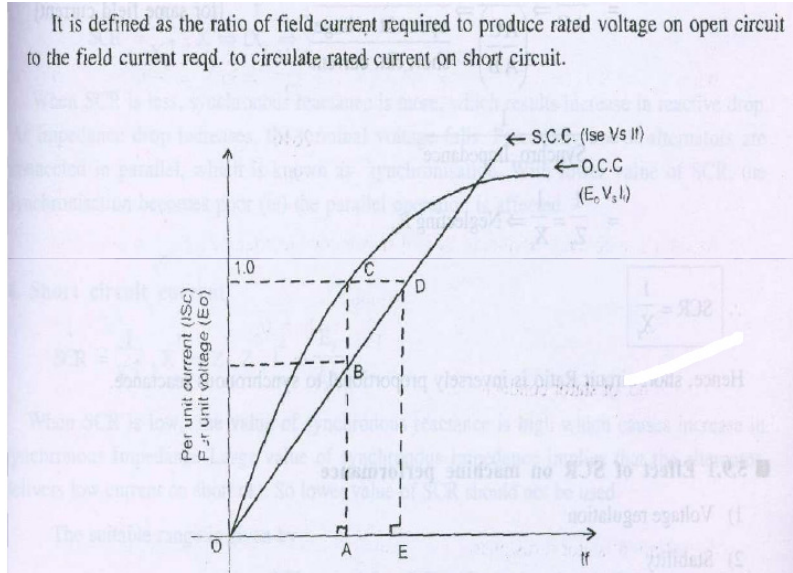

Explanation

The fig shows open Circuit and short Circuit characteristics of an alternator.

According to definition,

$$SCR = \frac{OA}{OE}$$

Triangles OAB and OED are similar

$$\text{Since } \frac{OAB}{OED} = \frac{OBA}{ODE}$$

$$\frac{OAB}{OED} = \frac{OBA}{ODE}$$

$$\frac{OAB}{OED} = \frac{OBA}{ODE}$$

$$\text{Now, } \frac{OA}{OE} = \frac{AB}{ED} = \frac{OB}{OD}$$

$$\therefore SCR = \frac{AB}{ED}$$

$$= \frac{AB}{AC} \Rightarrow \frac{1}{\left(\frac{AC}{AB}\right)} \Rightarrow \frac{1}{\frac{\text{open ckt voltage}}{\text{short ckt. current}}}$$

$$= \frac{1}{\text{Synchro Impedance}}$$

$$= \frac{1}{Z_s} = \frac{1}{X_s} \Rightarrow \text{Neglecting } R_a$$

Effect of SCR on Machine performance

1. Voltage regulation
2. Stability
3. Parallel operation
4. Short circuit Current
5. Cost and size of the machine

1. Voltage Regulation

$$\downarrow \text{SCR} = \frac{1}{X_s \uparrow}, E_o \uparrow = \sqrt{(V \cos \phi + IR_a)^2 + (V \sin \phi \pm IX_s)^2}$$

$$\uparrow R = \frac{E_o \uparrow - V}{V}$$

2. Stability

$$\downarrow \text{SCR} = \frac{1}{X_s \uparrow}, P_{\text{Syn. Max}} \Rightarrow \frac{EV}{X_s \uparrow}, P_{\text{Syn. Max}} \downarrow \Rightarrow \text{Stability}$$

3. Parallel operation: $\text{SCR} = 1/X_s$, as $\text{SCR} \uparrow$ $X_s \downarrow$ $IX_s \uparrow$ $V \downarrow$ $P_{\text{sync}} \downarrow$

4. Short circuit current

$$\downarrow \text{SCR} = \frac{1}{X_s \uparrow}, X_s \uparrow \Rightarrow Z_s \uparrow, Z_s \uparrow, I_{sc} \downarrow = \frac{E_s}{Z_s \downarrow}$$

5. Size and cost of the machine

as $\text{SCR} \downarrow$ $X_s \uparrow$ $Z_s \uparrow$ $I_{sc} \downarrow$ and hence cost of control equipment reduces

For salient pole machines SCR value varies from 0.9 to 1.3

For turbo alternators SCR value varies from 0.7 to 1.1

Length of the air gap:

Length of the air gap is a very important parameter as it greatly affects the performance of the machine. Air gap in synchronous machine affects the value of SCR and hence it influences many other parameters. Hence, choice of air gap length is very critical in case of synchronous machines. Following are the advantages and disadvantages of larger air gap.

Advantages:

- (i) Stability: Higher value of stability limit
- (ii) Regulation: Smaller value of inherent regulation
- (iii) Synchronizing power: Higher value of synchronizing power
- (iv) Cooling: Better cooling
- (v) Noise: Reduction in noise
- (vi) Magnetic pull: Smaller value of unbalanced magnetic pull

Disadvantages:

- (i) Field mmf: Larger value of field mmf is required
- (ii) Size: Larger diameter and hence larger size
- (iii) Magnetic leakage: Increased magnetic leakage
- (iv) Weight of copper: Higher weight of copper in the field winding
- (v) Cost: Increase over all cost.

Hence length of the air gap must be selected considering the above factors.

Calculation of Length of air Gap: Length of the air gap is usually estimated based on the ampere turns required for the air gap.

Armature ampere turns per pole required $AT_a = 1.35 T_{ph} k_w / p$

Where T_{ph} = Turns per phase, I_{ph} = Phase current, k_w = winding factor, p = pairs of poles

No load field ampere turns per pole $AT_{fo} = SCR \times$ Armature ampere turns per pole

$$AT_{fo} = SCR \times AT_a$$

Suitable value of SCR must be assumed.

Ampere turns required for the air gap will be approximately equal to 70 to 75 % of the no load field ampere turns per pole.

$$AT_g = (0.7 \text{ to } 0.75) AT_{fo}$$

$$\text{Air gap ampere turns } AT_g = 796000 B_g k_g l_g$$

Air gap coefficient or air gap contraction factor may be assumed varying from 1.12 to 1.18.

As a guide line, the approximate value of air gap length can be expressed in terms of pole pitch

For salient pole alternators: $l_g = (0.012 \text{ to } 0.016) \times$ pole pitch

For turbo alternators: $l_g = (0.02 \text{ to } 0.026) \times$ pole pitch

Synchronous machines are generally designed with larger air gap length compared to that of Induction motors.

Design of stator winding:

Stator winding is made up of former wound coils of high conductivity copper of diamond shape. These windings must be properly arranged such that the induced emf in all the phases of the coils must have the same magnitude and frequency. These emfs must have same wave shape and be displaced by 120° to each other. Single or double layer windings may be used depending on the requirement. The three phase windings of the synchronous machines are always connected in star with neutral earthed. Star connection of windings eliminates the 3rd harmonics from the line emf.

Double layer winding: Stator windings of alternators are generally double layer lap windings either integral slot or fractional slot windings. Full pitched or short chorded windings may be employed. Following are the advantages and disadvantages of double layer windings.

Advantages:

- (i) Better waveform: by using short pitched coil
- (ii) Saving in copper: Length of the overhang is reduced by using short pitched coils
- (iii) Lower cost of coils: saving in copper leads to reduction in cost
- (iv) Fractional slot windings: Only in double layer winding, leads to improvement in waveform

Disadvantages:

- (i) Difficulty in repair: difficult to repair lower layer coils
- (ii) Difficulty in inserting the last coil: Difficulty in inserting the last coil of the windings
- (iii) Higher Insulation: More insulation is required for double layer winding
- (iv) Wider slot opening: increased air gap reluctance and noise

Number of Slots:

The number of slots are to be properly selected because the number of slots affect the cost and performance of the machine. There are no rules for selecting the number of slots. But looking into the advantages and disadvantages of higher number of slots, suitable number of slots per pole per phase is selected. However the following points are to be considered for the selection of number of slots.

(a)

Advantages:

- (i) Reduced leakage reactance
- (ii) Better cooling
- (iii) Decreased tooth ripples

Disadvantages:

- (i) Higher cost
- (ii) Teeth becomes mechanically weak
- (iii) Higher flux density in teeth

(b) Slot loading must be less than 1500 ac/slot

(c) Slot pitch must be with in the following limitations

- (i) Low voltage machines ≤ 3.5 cm
- (ii) Medium voltage machines up to 6kV ≤ 5.5 cm
- (iv) High voltage machines up to 15 kV ≤ 7.5 cm

Considering all the above points number of slots per pole phase for salient pole machines may be taken as 3 to 4 and for turbo alternators it may be selected as much higher of the order of 7 to 9 slots per pole per phase In case of fractional slot windings number of slots per pole per phase may be selected as fraction 3.5.

Turns per phase:

Turns per phase can be calculated from emf equation of the alternator.

$$\text{Induced emf } E_{ph} = 4.44 f \Phi T_{ph} K_w$$

$$\text{Hence turns per phase } T_{ph} = E_{ph} / 4.44 f \Phi K_w$$

E_{ph} = induced emf per phase

Z_{ph} = no of conductors/phase in stator

T_{ph} = no of turns/phase

k_w = winding factor may assumed as 0.955

Conductor cross section: Area of cross section of stator conductors can be estimated from the stator current per phase and suitably assumed value of current density for the stator windings.

Sectional area of the stator conductor $a_s = I_s / \delta_s$ where δ_s is the current density in stator windings

I_s is stator current per phase

A suitable value of current density has to be assumed considering the advantages and disadvantages.

Advantages of higher value of current density:

- (i) reduction in cross section
- (ii) reduction in weight
- (iii) reduction in cost

Disadvantages of higher value of current density

- (i) increase in resistance
- (ii) increase in cu loss
- (iii) increase in temperature rise
- (iv) reduction in efficiency

Hence higher value is assumed for low voltage machines and small machines. Usual value of current density for stator windings is 3 to 5 amps/mm².

Stator coils:

Two types of coils are employed in the stator windings of alternators. They are single turn bar coils and multi turn coils. Comparisons of the two types of coils are as follows

- (i) Multi turn coil winding allows greater flexibility in the choice of number of slots than single turn bar coils.
- (ii) Multi turn coils are former wound or machine wound where as the single turn coils are hand made.
- (iii) Bending of top coils is involved in multi turn coils where as such bends are not required in single turn coils.
- (iv) Replacing of multi turn coils difficult compared to single turn coils.
- (v) Machine made multi turn coils are cheaper than hand made single turn coils.
- (vi) End connection of multi turn coils are easier than soldering of single turn coils.
- (vii) Full transposition of the strands of the single turn coils are required to eliminate the eddy current loss.
- (viii) Each turn of the multi turn winding is to be properly insulated thus increasing the amount of insulation and reducing the space available for the copper in the slot.

From the above discussion it can be concluded that multi turn coils are to be used to reduce the cost of the machine. In case of large generators where the stator current exceeds 1500 amps single turn coils are employed.

Single turn bar windings:

The cross section of the conductors is quite large because of larger current. Hence in order to eliminate the eddy current loss in the conductors, stator conductors are to be stranded. Each slot of the stator conductor consists of two stranded conductors as shown in Fig XXX. The dimensions of individual strands are selected based on electrical considerations and the manufacturing requirements. Normally the width of the strands is assumed between 4 mm to 7 mm. The depth of the strands is limited based on the consideration of eddy current losses and hence it should not exceed 3mm. The various strand of the bar are transposed in such a way as to minimize the circulating current loss.

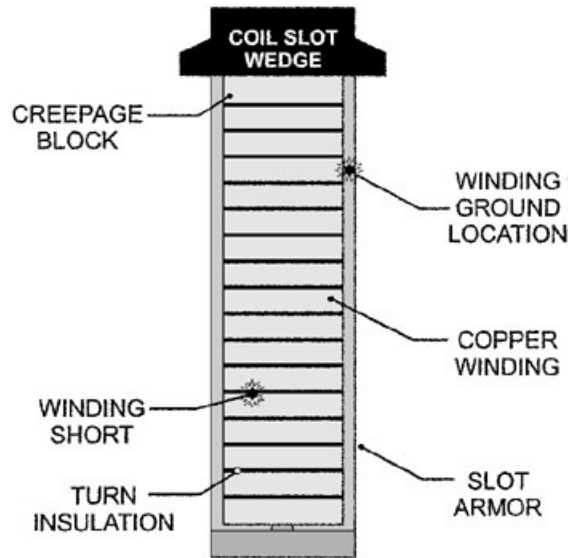

Fig XXX

Multi turn coils:

Multi turn coils are former wound. These coils are made up of insulated high conductivity copper conductors. Mica paper tape insulations are provided for the portion of coils in the slot and varnished mica tape or cotton tape insulation is provide on the over hang portion. The thickness of insulation is decided based on the voltage rating of the machine. Multi turn coils are usually arranged in double layer windings in slots as shown in Fig XXX.

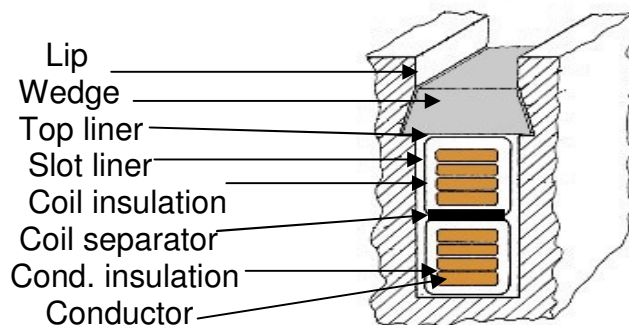

Fig. XXX

Dimensions of stator slot:

Width of the slot = slot pitch – tooth width

The flux density in the stator tooth should not exceed 1.8 to 2.0 Tesla. In salient pole alternators internal diameter is quite large and hence the flux density along the depth of the tooth does not vary appreciably. Hence width of the tooth may be estimated corresponding to the permissible flux density at the middle section of the tooth. The flux density should not exceed 1.8 Tesla. However in case of turbo alternators variation of flux density along the depth of the slot is appreciable and hence the width of the tooth may be estimated corresponding to the flux density at the top section of the tooth or the width of the tooth at the air gap. The flux density at this section should not exceed 1.8 Tesla.

For salient pole alternator:

Flux density at the middle section =

Flux / pole / (width of the tooth at the middle section x iron length x number of teeth per pole arc)

Number of teeth per pole arc = pole arc/slot pitch

For turbo alternators:

Flux density at the top section =

Flux / pole / (width of the tooth at the top section x iron length x number of teeth per pole pitch)

As the $\frac{2}{3}$ rd pole pitch is slotted the number of teeth per pole pitch =

$\frac{2}{3} \times \text{pole pitch} / (\text{slot pitch at top section})$

Slot width = slot pitch at the top section – tooth width at the top section.

Once the width of the slot is estimated the insulation required width wise and the space available for conductor width wise can be estimated.

Slot insulation width wise:

- (i) Conductor insulation
- (ii) Mica slot liner
- (iii) Binding tape over the coil
- (iv) Tolerance or clearance

Space available for the conductor width wise = width of the slot – insulation width wise

We have already calculated the area of cross section of the conductor. Using above data on space available for the conductor width wise depth of the conductor can be estimated. Now the depth of the slot may be estimated as follows.

Depth of the slot:

- (i) Space occupied by the conductor = depth of each conductor x no. of conductor per slot
- (ii) Conductor insulation
- (iii) Mica slot liner
- (iv) Mica or bituminous layers to separate the insulated conductors
- (v) Coil separator between the layers
- (vi) Wedge
- (vii) Lip
- (viii) Tolerance or clearance

Mean length of the Turn:

The length of the mean turn depends on the following factors

- (i) Gross length of the stator core: Each turn consists of two times the gross length of stator core.
- (ii) Pole pitch: The over hang portion of the coils depend upon the coil span which in turn depends upon the pole pitch.
- (iii) Voltage of the machine: The insulated conductor coming out of the stator slot should have straight length beyond the stator core which depends upon the voltage rating of the machine.
- (iv) Slot dimension: Length per turn depends on the average size of the slot.

Hence mean length of the turn in double layer windings of synchronous machines is estimated as follows.

$$l_{mt} = 2l + 2.5 \tau_p + 5 kV + 15 \text{ cm}$$

Numerical Problems:

Ex. 1 Design the stator frame of a 500 kVA, 6.6 kV, 50 Hz, 3 phase, 12 pole, star connected salient pole alternator, giving the following informations.

- (i) Internal diameter and gross length of the frame
- (ii) Number of stator conductors
- (iii) Number of stator slots and conductors per slot

Specific magnetic and electric loadings may be assumed as 0.56 Tesla and 26000 Ac/m respectively. Peripheral speed must be less than 40 m/s and slot must be less than 1200.

Soln:

- (i) Diameter and gross length of stator:

Assuming the winding to be full pitched $K_w = 0.955$

$$\begin{aligned} \text{Output coefficient } C_o &= 11 \times B_{av} \times q \times K_w \times 10^{-3} \\ &= 11 \times 0.56 \times 26000 \times 0.955 \times 10^{-3} \\ &= 153 \end{aligned}$$

$$\begin{aligned} \text{Speed in rps } n_s &= 2f/p = 2 \times 50/12 \\ &= 8.33 \text{ rps} \end{aligned}$$

$$\text{Output } Q = C_o D^2 L n_s =$$

$$\begin{aligned} D^2 L &= Q / C_o n_s = 500 / (153 \times 8.33) \\ &= 0.392 \text{ m}^3 \end{aligned}$$

Using round poles for the salient pole alternator and assuming ratio of pole arc to pole pitch as 0.65 and pole arc equal to core length

$$\text{Pole arc} / \text{pole pitch} = \text{core length} / \text{pole pitch} = 0.65$$

$$L = \pi D / p = \pi D / 12$$

$$L = 0.17D$$

Substituting this relation in D^2L product and solving for D and L
 $D = 1.32 \text{ m}$ and $L = 0.225 \text{ m}$.

$$\begin{aligned}\text{Peripheral speed} &= \pi D n_s \text{ m/s} \\ &= \pi \times 1.32 \times 8.33 \\ &= 34.6 \text{ m/s (with in limitations)}\end{aligned}$$

(ii) Number of stator conductors

$$E_{ph} = 6600/\sqrt{3} = 3810 \text{ volts}$$

$$\begin{aligned}\text{Air gap flux per pole} &= B_{av} \times \pi DL/p \\ &= 0.56 \times \pi \times 1.32 \times 0.225/12 \\ &= 0.0436 \text{ wb}\end{aligned}$$

We have $E_{ph} = 4.44f \Phi T_{ph} K_w$

$$\begin{aligned}\text{Hence } T_{ph} &= 3810 / (4.44 \times 50 \times 0.955 \times 0.0436) \\ &= 412\end{aligned}$$

Total number of stator conductors/phase = $412 \times 2 = 824$ conductors

$$\text{Total number of conductors} = 412 \times 6 = 2472$$

(iii) Number of stator slots and conductors per slot

Considering the guide lines for selection of number of slots

Selecting the number of slots/pole/phase = 3

$$\text{Total number of slots} = 3 \times 12 \times 3 = 108$$

$$\begin{aligned}\text{Slot pitch} &= \pi D/S \\ &= \pi \times 132 / 108 \\ &= 2.84 \text{ cm (quite satisfactory)}\end{aligned}$$

$$\begin{aligned}\text{Number of conductors per slot} &= 2472/108 \\ &\approx 24\end{aligned}$$

$$\text{Hence total number of conductors} = 24 \times 108 = 2592$$

$$\text{Turns per phase} = 2592/6 = 432$$

Slot loading:

$$\begin{aligned}\text{Full load current} &= 500 \times 10^3 / (\sqrt{3} \times 6600) \\ &= 43.7 \text{ amps}\end{aligned}$$

Slot loading = current per conductor x number of conductors/ slot

$$= 43.7 \times 24$$
$$= 1048.8 \text{ (satisfactory)}$$

Ex. 2. A 3 phase 1800 kVA, 3.3 kV, 50 Hz, 250 rpm, salient pole alternator has the following design data.

Stator bore diameter = 230 cm

Gross length of stator bore = 38 cm

Number of stator slots = 216

Number of conductors per slot = 4

Sectional area of stator conductor = 86 mm²

Using the above data, calculate

- (i) Flux per pole
- (ii) Flux density in the air gap
- (iii) Current density
- (iv) Size of stator slot

Soln:

- (i) Flux per pole

$$E_{ph} = 3300/\sqrt{3} = 1905 \text{ volts}$$

$$\text{Number of slots per phase } 216/3 = 72$$

$$\text{Number of conductors per slot} = 4$$

$$\text{Total number of conductors per phase} = 72 \times 4 = 288$$

$$\text{Number of turns per phase } T_{ph} = 288/2 = 144$$

We have from emf equation $E_{ph} = 4.44f \Phi T_{ph} K_w$

Assuming $K_w = 0.955$

$$\begin{aligned} \text{Flux per pole } \Phi &= E_{ph} / (4.44f T_{ph} K_w) \\ &= 1905 / (4.44 \times 50 \times 144 \times 0.955) \\ &= 0.0624 \text{ wb} \end{aligned}$$

- (ii) Flux density in the air gap

$$\text{Air gap flux per pole} = B_{av} \times \pi DL/p$$

$$D = 230 \text{ cm,}$$

$$L = 38 \text{ cm,}$$

$$N_s = 250 \text{ rpm}$$

$$P = 24$$

$$\begin{aligned} B_{av} &= \Phi / \pi DL/p \\ &= 0.0624 \times 24 / (\pi \times 2.3 \times 0.38) \\ &= 0.55 \text{ Tesla} \end{aligned}$$

- (iii) Current density

Sectional area of the conductor = 86 mm^2
 Full load current of the machine = $1800 \times 10^3 / (\sqrt{3} \times 3300)$
 = 314.9 amps
 Hence Current density = $314.9/86$
 = 3.7 amp/mm^2

(iv) Size of the stator slot

Before fixing up the width of the slot flux density in the middle section of the tooth has to be assumed as 1.7 Tesla. Based on this flux density width of the slot at the middle section can be found.

Flux per pole = 0.0624 wb
 Gross length of the core = 38 cm
 Assume
 Number of ventilating duct = 4
 Width of the ventilating duct = 1cm
 Iron space factor = 0.92
 Net iron length of the core $l_i = (L - nd \times wd)k_i$
 = $(38 - 4 \times 1) 0.92$
 = 31.28 cm

Pole pitch = $\pi D/p$
 = $\pi \times 230/24$
 = 30.12 cm
 Pole arc/ pole pitch = 0.65 (Assumed)
 Pole arc = 0.65 x pole pitch
 = 0.65 x 30.12
 = 19.6 cm

Number of stator teeth = 216
 Slot pitch = $\pi D/s$
 = $\pi \times 230/216$
 = 3.35 cm
 Number of teeth per pole arc = pole arc/ slot pitch
 = $19.6/3.35$
 = 6

Flux density in stator teeth = flux per pole / ($b_t \times l_i \times$ number of teeth per pole arc)
 $b_t = 0.0624 / (1.7 \times 0.3128 \times 6)$
 = 1.95 cm

Thus the width of the slot should not exceed = $3.35 - 1.95$
 = 1.4 cm

Slot insulation width wise:

(i) Conductor insulation	2 x 0.5	= 1.0 mm
(ii) Micanite slot liner	2 x 1.5	= 3.0 mm
(iii) Binding tape	2 x 0.4	= 0.8 mm
(iv) tolerance		= 1.2 mm

$$\text{Total} = 6.0 \text{ mm}$$

$$\begin{aligned} \text{Maximum space available for the conductor width wise} &= \text{width of the slot} - \text{insulation width wise} \\ &= 1.4 - 0.6 \\ &= 0.8 \text{ cm} \end{aligned}$$

$$\text{Area of cross section of the conductor} = 86 \text{ mm}^2$$

$$\text{Hence thickness of the conductor} = 86/8 = 10.75 \text{ mm}$$

$$\text{Hence the dimension of the standard conductor selected} = 7.8 \text{ mm} \times 11.0 \text{ mm}$$

$$\text{Hence the width of the conductor} = 7.8 + 6.0 = 13.8 \text{ mm} = 1.38 \text{ cm}$$

Arrangement of the conductor:

All the four conductors are arranged depth wise

Depth of the slot:

(i) Space occupied by the conductor	4 x 11	= 44.0 mm
(ii) Conductor insulation	4 x 2 x 0.5	= 4.0 mm
(iii) Micanite slot liner	2 x 1.5	= 3.0 mm
(iv) Bituminous insulation between the insulated conductors	(4-1) x 0.2	= 0.6 mm
(v) Binding tape on the conductors	2 x 0.4	= 0.8 mm
(vi) Lip		= 1.5 mm
(vii) Wedge		= 3.5 mm
(viii) Tolerance		= 1.6 mm
	Total	59 mm

$$\text{Size of the slot} = 1.38 \text{ cm} \times 5.9 \text{ cm}$$

Ex.3. A water wheel generator with power output of 4750 kVA, 13.8 kV, 50 Hz, 1000 rpm, working at a pf of 0.8 has a stator bore and gross core length of 112 cm and 98 cm respectively. Determine the loading constants for this machine.

Using the design constants obtained from the above machine determine the main dimensions of the water wheel generator with 6250 kVA, 13.8 kV, 50 Hz, 750 rpm operating at a power factor of 0.85. Also determine (i) Details of stator winding (ii) Size of the stator slot, (iii) Copper losses in the stator winding.

For 4750 kVA Generator:

$$D = 112 \text{ cm}$$

$$L = 98 \text{ cm}$$

$$N_s = 1000 \text{ rpm}$$

$$N_s = 1000/60 = 16.67 \text{ rps}$$

$$\text{kVA out put } Q = C_0 D^2 L n_s$$

$$C_0 = Q / D^2 L n_s$$

$$= 4750 / [(1.12)^2 \times 0.98 \times 16.67]$$

$$= 232$$

$$\text{Output coefficient } C_o = 11 \times B_{av} \times q \times K_w \times 10^{-3}$$

$$\begin{aligned} \text{Hence } B_{av} \times q &= C_o / (11 \times K_w \times 10^{-3}) \\ &= 232 / (11 \times 0.955 \times 10^{-3}) \\ &= 22200 \end{aligned}$$

Assuming the flux density of 0.6 Tesla

$$\text{Hence } q = 22200/0.6 = 37000 \text{ Ac/m}$$

Main Dimensions of the second machine:

$$\text{kVA out put } Q = C_o D^2 L n_s$$

$$C_o = 232$$

$$Q = 6250 \text{ kVA}$$

$$N_s = 750 \text{ rpm}$$

$$N_s = 750/60 = 12.5 \text{ rps}$$

$$\begin{aligned} D^2 L &= Q / C_o n_s \\ &= 6250 / 232 \times 12.5 \\ &= 2.16 \text{ m}^3 \end{aligned}$$

$$\begin{aligned} \text{For the first machine pole pitch } \tau_p &= \pi D/p \\ &= \pi \times 112/6 \\ &= 58.6 \text{ cm} \end{aligned}$$

$$\begin{aligned} \text{Core length / pole pitch} &= \text{gross length/ pole pitch} \\ &= 98/58.6 \\ &= 1.67 \end{aligned}$$

$$\text{No. of poles for the second machine } p = 120f/N_s = 120 \times 50 / 750 = 8$$

Assuming the same ratio of gross length to pole pitch for the second machine as that of first machine

$$\begin{aligned} L / \pi D/p &= 1.67 \\ L &= 1.67 \times \pi D/8 \\ &= 0.655 D \end{aligned}$$

$$\text{We have } D^2 L = 2.16 \text{ m}^3$$

Substituting the value of L in $D^2 L$ and solving for D & L

$$D = 149 \text{ cm and } L = 97.5 \text{ cm}$$

$$\text{Peripheral speed for machine 1: } \pi D N_s / 60 = \pi \times 1.12 \times 1000/60 = 58.5 \text{ m/s}$$

Peripheral speed for machine 2: $\pi D N_s / 60 = \pi \times 1.49 \times 750 / 60 = 58.5 \text{ m/s}$

As the peripheral speed is same for both the machines the diameter and length of the machine are satisfactory.

Stator winding details:

Assuming star connection emf per phase $E_{ph} = 13.8 / \sqrt{3} = 7960 \text{ volts}$

We have from emf equation $E_{ph} = 4.44 f \Phi T_{ph} K_w$

Assuming $K_w = 0.955$, $f = 50 \text{ Hz}$

Air gap flux per pole $\Phi = B_{av} \times \pi DL / p$

Assuming the air gap flux density of machine 2 same as that of machine 1 $B_{av} = 0.6 \text{ Tesla}$

Hence $\Phi = B_{av} \times \pi DL / p = 0.6 \times \pi \times 1.49 \times 0.975 / 8 = 0.342 \text{ wb}$

Hence $T_{ph} = E_{ph} / (4.44 f \Phi K_w)$
 $= 7960 / (4.44 \times 50 \times 0.342 \times 0.955)$
 $= 110$

Total number of Conductors $= 110 \times 6 = 660$

Full load current per phase $I_{ph} = 6250 \times 10^3 / \sqrt{3} \times 13.8 \times 10^3$
 $= 262 \text{ amps}$

Assuming number of slots per pole per phase $= 4 \frac{1}{2}$

Total number of slots $= 4.5 \times 8 \times 3 = 108$

Slot pitch $= \pi D / s = \pi \times 149 / 108 = 4.35 \text{ cm}$ (quite satisfactory)

Number of conductors per slot $= 660 / 108 \approx 6$

Total number of conductors revised $= 108 \times 6 = 648$

Number of turns/phase $= 108$

Total slot loading $= I_{ph} \times \text{Cond/slot}$
 $= 262 \times 6 = 1572 \text{ amp cond}$ (quite satisfactory)

Dimension of the stator slot:

Full load current per phase $I_{ph} = 6250 \times 10^3 / \sqrt{3} \times 13.8 \times 10^3$
 $= 262 \text{ amps}$

Assuming a current density of 4.2 amps/mm^2

Area of cross section of the conductor $= 262 / 4.2 = 62.4 \text{ mm}^2$

Based on the allowable flux density, width of the stator tooth can be calculated and then the width of the slot can be estimated.

Flux density in stator tooth $B_t = \Phi / (\text{Number of teeth/pole arc} \times \text{width of the teeth} \times \text{Iron length})$

In a large salient pole alternator the flux density in the tooth along the depth of the tooth does not vary appreciably. Thus the flux density at the top of the tooth may be assumed as 1.7 Tesla and the width of the tooth is calculated at the top section.

Hence number of teeth per pole arc = pole arc/ slot pitch

Assuming pole arc/ pole pitch = 0.65

Pole arc = 0.65 x 58.6 = 38.1 cm

Thus the number of teeth per pole arc = 38.1/4.35 = 9

Net Iron length = $(L - n_d w_d) k_i$

Assuming 10 ventilating ducts of each 1 cm width and an iron space factor of 0.92

$L_i = (97.5 - 10 \times 1)0.92 = 80.5 \text{ cm} = 0.805 \text{ m}$

$$B_t = \Phi / (\text{Number of teeth/pole arc} \times L_i)$$

$$= 0.342 / (9 \times b_t \times 0.805)$$

Assuming the flux density B_t as 1.7 Tesla

Hence width of the teeth = 2.78 cm

We have the slot pitch = 4.35 cm

Thus the slot pitch = 4.35 – 2.78 = 1.55 cm

Slot insulation width wise:

Slot insulation width wise:

(i) Conductor insulation	2 x 0.5	= 1.0 mm
(ii) Micanite slot liner	2 x 1.5	= 3.0 mm
(iii) Binding tape	2 x 0.25	= 0.5 mm
(iv) tolerance		= 1.0 mm
	Total	= 5.5 mm

Insulation depth wise:

(i) Conductor insulation	6 x 2 x 0.5	= 6.0 mm
(ii) Micanite slot liner	2 x 1.5	= 3.0 mm
(iii) Bituminous insulation between the insulated conductors	(6-1) x 0.3	= 1.5 mm
(iv) coil separator between layers		= 0.4 mm
(iv) Binding tape on the conductors	6 x 2 x 0.25	= 3.0 mm
(v) Lip		= 1.0 mm
(vi) Wedge		= 3.0 mm
(vii) Tolerance		= 1.6 mm

Total	19.5 mm
-------	---------

Maximum space available for the conductor width wise = width of the slot – insulation width wise
 = 1.55 – 0.55
 = 1.0 cm

The area of cross section of the conductor = 62.4 mm²

Approximate depth of the conductor = 62.4/ 10 = 6.2 mm

Selecting the standard conductor of size 9 mm x 7 mm

Thus the area of the conductor = 63 mm²

Six conductors are arranged as 3 conductors depth wise in two layers.

Hence width of the slot = 9 mm + 5.5 mm = 14.5 mm = 1.45 cm

Depth of the slot = 6 x 7 + 19.5 mm = 61.5 mm = 6.15 cm

Copper loss in stator winding

Approximate length of the mean turn = (2L + 2.5 τ_p + 5 x kV + 15)
 = (2 x 97.5 + 2.5 x 58.6 + 5 x 13.8 + 15)
 = 426 cm
 = 4.26 m

Resistance of the stator winding = ζ x l_{mt} x T_{ph} / a
 = 0.021 x 4.26 x 108 / 63
 = 0.153 ohm

Total Copper losses = 3 I²R
 = 3 x (262)² x 0.153
 = 31500 watts

Ex. 4. Two preliminary designs are made for a 3 phase alternator, the two designs differing only in number and size of the slots and the dimensions of the stator conductors. The first design uses two slots per pole per phase with 9 conductors per slot, each slot being 75 mm deep and 19 mm wide, the mean width of the stator tooth is 25 mm. The thickness of slot insulation is 2 mm, all other insulation may be neglected. The second design is to have 3 slots per pole per phase. Retaining the same flux density in the teeth and current density in the stator conductors as in the first design, calculate the dimensions of the stator slot for the second design. Total height of lip and wedge may be assumed as 5 mm.

Sln.

First Design:

Slot per pole per phase q = 2

Total height of the conductor = 75 – 5 – 2 x 2 = 66 mm

Height of each conductor = 66/9 = 7.33 mm

Width of each conductor = 19 - 2 x 2 = 15 mm

Area of each conductor = 7.33 x 15 = 110 mm²

Slot pitch at mean diameter = slot width + tooth width = 19 + 25 = 44 mm

Second Design:

Slots per pole per phase = 3

Hence, the number of stator slots in this design are 3/2 times that in the first design.

Retaining the same flux density in the teeth and current density in the stator conductors

The number of conductors per slot in this design is 2/3 times that in the first design.

Number of conductors per slot = 2/3 x 9 = 6

Slot pitch at mean diameter = 2/3 x 44 = 29.3 mm

Tooth width at the same flux density = 2/3 x 25 = 16.7 mm

Hence slot width = 29.3 - 16.7 = 12.6 mm

Width of each conductor = 12.6 - 2 x 2 = 8.6 mm

Height of each conductor = 110/8.6 = 12.8 mm

Total height of the conductor = 6 x 12.8 = 76.8 mm

Conductor dimensions 12.8 x 8.6 mm²

Depth of the slot = 76.8 + 5 + 2 x 2 = 85.8 mm

Slot dimensions = 85.8 x 12.6 mm²

Ex. 5. A 1000 kVA, 3300 volts, 50 Hz, 300 rpm, 3 phase alternator has 180 slots with 5 conductors per slot. Single layer winding with full pitched coils is used. The winding is star connected with one circuit per phase. Determine the specific electric and magnetic loading if the stator bore is 2 m and core length is 0.4 m. Using the same specific loadings determine the design details for a 1250 kVA, 3300 volts, 50 Hz, 250 rpm, 3 phase star connected alternator having 2 circuits per phase. The machines have 60° phase spread.

Sln: Total stator conductors = 180 x 5 = 900

Turns per phase = 900 / 6 = 150

Synchronous speed = 300/60 = 5 rps

Number of poles = 120f / N_s = 120 x 50 / 300 = 20

Slots per pole per phase = 180 / (20 x 3) = 3

Distribution factor = (sin 60/2) / (3 sin 60/6) = 0.96

For Full pitched winding, pitch factor k_p = 1

Winding factor = k_p x k_d = 0.96

E_{ph} = 3300/√3 = 1910 volts

Flux per pole Φ = 1910 / (4.44 x 50 x 150 x 0.96) = 59.8 mwb

Pole pitch = πD/p = π x 2 / 20 = 0.314 m

Area of one pole pitch A_p = pole pitch x core length = 0.314 x 0.4 = 125.6 x 10⁻³ m²

Specific magnetic loading = Φ / A_p = 59.8 x 10⁻³ / 125.6 x 10⁻³ = 0.476 Tesla

Current per phase I_{ph} = 1000 x 10³ / (3 x 1910) = 175 amps

As there is one circuit per phase current per conductor = 175 amps

Specific electric loading = 3 I_{ph} z_{ph} / πD = 6 I_{ph} T_{ph} / πD = 6 x 175 x 150 / (π x 2) = 25000 Ac/m

Peripheral speed = πDN_s/60 = π x 2 x 300/60 = 31.4 m/s

1250 kVA generator

Synchronous speed = 250/60 = 4.167 rps

Number of poles = 120f / N_s = 120 x 50 / 250 = 24

Winding factor = 0.96

Output coefficient C₀ = 11 B_{av} q K_w x 10⁻³ = 11 x 0.476 x 0.96 x 25000 x 10⁻³ = 126

$$D^2L = Q / C_0 n_s = 1250 / (126 \times 4.167) = 2.39 \text{ m}^3$$

Keeping the peripheral speed same as that of the first machine

$$\pi D N_s / 60 = \pi \times D \times 250 / 60 = 31.4 \text{ m/s}$$

Hence $D = 2.4 \text{ m}$ and $L = 0.414 \text{ m}$

$$\text{Pole pitch} = \pi D / p = \pi \times 2.4 / 24 = 0.314 \text{ m}$$

$$\text{Flux per pole} = B_{av} \times \pi D L / p = 0.476 \times 0.314 \times 0.414 = 0.062 \text{ wb}$$

When there are more than one circuit per phase (number of parallel paths = a)

$$\text{Voltage per phase } E_{ph} = 4.44 f \Phi T_{ph} K_w / a; \quad a = 2$$

$$\text{Hence } T_{ph} = (2 \times 1910) / (4.44 \times 50 \times 0.062 \times 0.96) = 289$$

$$\text{Total number of conductors} = 6 T_{ph} = 6 \times 289 = 1734$$

$$\text{Total number of slots} = 3 \times 24 \times 3 = 216$$

$$\text{Number of conductors per slot} = 1734 / 216 \approx 8$$

$$\text{Revised number of conductors} = 8 \times 216 = 1728$$

$$\text{Revised number of turns per phase} = 1728 / 6 = 288$$

Ex. 6. Determine the main dimensions of a 75 MVA, 13.8 kV, 50 Hz, 62.5 rpm, 3 phase star connected alternator. Also find the number of stator slots, conductors per slot, conductor area and work out the winding details. The peripheral speed should be less than 40 m/s. Assume average gap density as 0.65 wb/m^2 , Specific electric loading as 40,000 AC/m and current density as 4 amp/mm^2 .

Soln:

$$\text{Synchronous speed} = 62.5 / 60 = 1.0417 \text{ rps}$$

$$\text{Number of poles} = 120f / N_s = 120 \times 50 / 62.5 = 96$$

$$\text{Winding factor} = 0.955$$

$$\text{Output coefficient } C_0 = 11 B_{av} q K_w \times 10^{-3} = 11 \times 0.65 \times 0.955 \times 40000 \times 10^{-3} = 273$$

$$D^2L = Q / C_0 n_s = 75000 / (273 \times 1.0417) = 264 \text{ m}^3$$

Taking the peripheral speed as 40 m/s

$$\text{Peripheral speed} = \pi D N_s / 60$$

$$\text{Hence } D = 40 \times 60 / \pi \times 300 = 12.2 \text{ m} \text{ and } L = 1.77 \text{ m}$$

$$\text{Pole pitch} = \pi D / p = \pi \times 12.2 / 96 = 0.4 \text{ m}$$

$$\text{Flux per pole} = B_{av} \times \pi D L / p = 0.65 \times 0.4 \times 1.77 = 0.46 \text{ wb}$$

$$E_{ph} = 13800 / \sqrt{3} = 7960 \text{ volts}$$

Assuming one circuit per phase

$$\text{Turns per phase } T_{ph} = E_{ph} / 4.44 f \Phi K_w = 7960 / (4.44 \times 50 \times 0.46 \times 0.955) \approx 82$$

As the terminal voltage of the machine is 13.8 kV slot pitch of about 5.5 cm should be used.

$$\text{Hence the number of slots} = \pi D / \tau_s = \pi \times 12.2 \times 100 / 5.5 = 696$$

$$\text{Number of slots per pole per phase} = S / 3p = 696 / (3 \times 96) = 2.42$$

The above fractional value of slots per pole per phase indicates that fractional slot winding is used. Number of slots and turns per phase must be finalized such that they should not differ significantly from the earlier calculated values.

It is also to be noted that for fractional slot winding double layer winding is a must and hence conductors per slot must be an even.

Assuming number of slots per pole per phase as 2.5

$$\text{Total number of slots} = 2.25 \times 3 \times 96 = 648$$

$$\text{Total number of conductors} = 2 \times 3 \times T_{ph} = 6 \times 82 = 492$$

$$\text{Hence number of conductors per slot} = 492 / 648 = \text{fraction}$$

Hence a double layer winding is not possible with one circuit per phase. Hence the number of circuits is to be selected in such a way that number of conductors per slot is even and the winding becomes symmetrical.

Taking the number parallel circuits as $a = 8$

$$\text{Turns per phase } T_{ph} = a \times E_{ph} / 4.44f \Phi K_w = 8 \times 7960 / (4.44 \times 50 \times 0.46 \times 0.955) \approx 654$$

$$\text{Hence total number of conductors} = 2 \times 3 \times T_{ph} = 6 \times 654 = 3924$$

$$\text{Number of conductors per slot} = 3924 / 648 \approx 6$$

$$\text{Hence the number of conductors} = 6 \times 648 = 3888$$

$$\text{Hence turns per phase } T_{ph} = 3888 / 6 = 648$$

$$\text{Current per phase} = (75000 \times 10^3) / (3 \times 7960) = 3140 \text{ amps}$$

$$\text{Current in each conductor} = \text{Current per parallel path} = 3140 / 8 = 392.5 \text{ amps}$$

$$\text{Area of cross section of each conductor} = 392.5 / 4 = 98.125 \text{ mm}^2$$

Area of cross section of conductor being very large conductors are stranded and used.

Ex.7. Calculate the stator dimensions for 5000 kVA, 3 phase, 50 Hz, 2 pole alternator. Take mean gap density of 0.5 wb/m², specific electric loading of 25,000 ac/m, peripheral velocity must not exceed 100 m/s. Air gap may be taken as 2.5 cm.

$$\text{Soln: Output } Q = C_o D^2 L n_s \text{ kVA}$$

$$C_o = 11 B_{av} q K_w \times 10^{-3}$$

$$\text{Assuming } K_w = 0.955$$

$$C_o = 11 \times 0.5 \times 25000 \times 0.955 \times 10^{-3} \\ = 130$$

$$n_s = 120f/p = 120 \times 50 / 2 = 3000$$

$$n = 3000 / 60 = 50 \text{ rps}$$

$$D^2 L = Q / C_o n_s$$

$$= 5000 / (130 \times 50)$$

$$= 0.766 \text{ m}^3$$

$$\text{Peripheral velocity} = \pi D r n_s / 60 \\ = 100 \text{ m/s}$$

$$D r = 100 / (50 \times \pi)$$

$$= 63.5 \text{ cm}$$

$$D = D r + 2l_g$$

$$= 63.5 + 2 \times 2.5$$

$$= 68.5 \text{ cm}$$

$$L = 163 \text{ cm}$$

Numerical Problems: Turbo alternators

Ex.1. Calculate the stator dimensions for 5000 kVA, 3 phase, 50 Hz, 2 pole alternator. Take mean gap density of 0.5 wb/m², specific electric loading of 25,000 ac/m, peripheral velocity must not exceed 100 m/s. Air gap may be taken as 2.5 cm.

$$\text{Soln: Output } Q = C_o D^2 L n_s \text{ kVA}$$

$$C_o = 11 B_{av} q K_w \times 10^{-3}$$

Assuming $K_w = 0.955$

$$C_o = 11 \times 0.5 \times 25000 \times 0.955 \times 10^{-3} \\ = 130$$

$$N_s = 120f/p = 120 \times 50 / 2 = 3000 \text{ rpm}$$

$$n_s = 3000/60 = 50 \text{ rps}$$

$$D^2L = Q / C_o n_s$$

$$= 5000 / (130 \times 50)$$

$$= 0.766 \text{ m}^3$$

$$\text{Peripheral velocity} = \pi D_r N_s / 60 \\ = 100 \text{ m/s}$$

$$D_r = 100 / (50 \times \pi)$$

$$= 63.5 \text{ cm}$$

$$D = D_r + 2l_g$$

$$= 63.5 + 2 \times 2.5$$

$$= 68.5 \text{ cm}$$

$$L = 163 \text{ cm}$$

Ex.2. A 3000 rpm, 3 phase, 50 Hz, turbo alternator

Has a core length of 0.94 m. The average gap density

is 0.45 Tesla and the ampere conductors per m are 25000. The peripheral speed of the rotor is 100 m/s and the length of the air gap is 20mm. Find the kVA output of the machine when the coils are (i) full pitched (ii) short chorded by 1/3rd pole pitch. The winding is infinitely distributed with a phase spread of 60°.

Soln:

$$\text{Synchronous speed } N_s = 3000 \text{ rpm}$$

$$n_s = 3000/60 = 50 \text{ rps}$$

$$\text{Peripheral speed } n_p = \pi D_r N_s / 60$$

$$= 100 \text{ m/s}$$

$$\text{Hence diameter of the rotor } D_r = 100 \times 60 / (\pi \times 3000)$$

$$= 0.637 \text{ m}$$

$$\text{Hence inner diameter of stator } D = D_r + 2l_g$$

$$= 0.637 + 2 \times 0.02$$

$$= 0.677 \text{ m}$$

(i) With infinite distribution and 60° phase spread the distribution factor may be given by where α is the phase spread

$$K_d = \sin \sigma/2 / \sigma/2 = \sin \pi/6 / \pi/6 = 0.955$$

With full pitched coils $K_p = 1$

$$\text{Winding factor} = K_p \times K_d = 0.955$$

$$\text{Output of the machine } Q = C_o D^2 L n_s$$

$$= 11 B_{av} q K_w \times D^2 L n_s \times 10^{-3}$$

$$= 11 \times 0.45 \times 25000 \times 0.955 \times 0.6672 \times 0.94 \times 50 \times 10^{-3}$$

$$= 2480 \text{ kVA}$$

(ii) With chording of 1/3rd of pole pitch:

chording angle $\alpha = 180/3 = 60^\circ$

Pitch factor = $\cos \alpha / 2 = 0.866$

Winding factor = $K_p \times K_d = 0.955 \times 0.866 = 0.827$

$$\begin{aligned} \text{Output of the machine } Q &= C_0 D^2 L n_s \\ &= 11 B_{av} q K_w \times D^2 L n_s \times 10^{-3} \\ &= 11 \times 0.45 \times 25000 \times 0.827 \times 0.6672 \times 0.94 \times 50 \times 10^{-3} \\ &= 2147 \text{ kVA} \end{aligned}$$

Ex. 3. Estimate the stator dimensions, size and number

of conductors and number of slots of 15 MVA 11kV,

3 phase, 50 Hz, 2 pole turbo alternator with 60° phase spread.

Assume Specific electric loading = 36000 AC/m, specific magnetic loading = 0.55 Tesla,

Current density = 5 Amp/mm², peripheral speed = 160 m/s. The winding must be designed to eliminate 5th harmonic.

Soln: Synchronous speed $N_s = 120f/p = 120 \times 50 / 2 = 3000 \text{ rpm}$

$$n_s = 3000/60 = 50 \text{ rps}$$

Peripheral speed $v_p = \pi D r N_s / 60$

$$= 160 \text{ m/s}$$

Hence diameter of the rotor $D_r \approx D$

$$= 160 \times 60 / (\pi \times 3000)$$

$$= 1 \text{ m}$$

With a phase spread of 60° distribution factor

$$K_d = \sin \sigma/2 / \sigma/2 = \sin \pi/6 / \pi/6 = 0.955$$

In order to eliminate 5th harmonic chording angle $\alpha = 180/5 = 36^\circ$

$$\text{Pitch factor } K_p = \cos \alpha / 2 = 0.951$$

$$\text{Winding factor} = K_p \times K_d = 0.955 \times 0.951 = 0.908$$

$$\begin{aligned} \text{Output coefficient } C_0 &= 11 B_{av} q K_w \times 10^{-3} \\ &= 11 \times 0.55 \times 36000 \times 0.908 \times 10^{-3} \\ &= 198 \end{aligned}$$

$$\begin{aligned} D^2 L &= Q / C_0 n_s \\ &= 15000 / (198 \times 50) = 1.51 \text{ m}^3 \end{aligned}$$

We have $D = 1 \text{ m}$ and $D^2 L = 1.51 \text{ m}^3$

Solving for L, $L = 1.51 \text{ m}$

$$\begin{aligned} \text{Flux per pole} &= B_{av} \times \pi D L / p \\ &= 0.55 \times \pi \times 1 \times 1.51 / 2 \\ &= 1.3 \text{ wb} \end{aligned}$$

$$E_{ph} = 1100 / \sqrt{3} = 6360 \text{ volts}$$

$$\begin{aligned} \text{Hence } T_{ph} &= E_{ph} / 4.44 f \Phi K_w \\ &= 6360 / (4.44 \times 50 \times 1.3 \times 10^{-3} \times 0.908) \\ &= 24 \end{aligned}$$

$$\begin{aligned} \text{Total number of conductors} &= 6 \times 24 \\ &= 144 \end{aligned}$$

For the turbo alternator selecting slots/pole/phase = 5

Total number of stator slots = $5 \times 2 \times 3 = 30$

Conductors/slot = $144 / 30 = 5$

can not use double layer winding,
using two circuits per phase
conductors/slot = 10

Total conductors $10 \times 30 = 300$.

Design of the field System: Salient pole Alternator:

Dimension of the pole:

- (i) Axial Length of the pole: Axial length of the pole may be assumed 1 to 1.5 cm less than that of the stator core.
- (ii) Width of the pole: Leakage factor for the pole is assumed varying between 1.1 to 1.15.
Thus the flux in the pole body = 1.1 to 1.15Φ
Area of the pole = Flux in the pole body / Flux density in the pole body.
Flux density in the pole body is assumed between 1.4 to 1.6 wb/m^2 .
Area of the pole = width of the pole x net axial length of the pole.
Net axial length of the pole = gross length x stacking factor
Stacking factor may be assumed as 0.93 to 0.95 .
Hence width of the pole = Area of the pole / net axial length of the pole.
- (iii) Height of the pole:

Height of the pole is decided based on the mmf to be provided on the pole by the field winding at full load. Hence it is required to find out the mmf to be provided on the pole at full load before finding the height of the pole. Full load field ampere turns required for the pole can be calculated based on the armature ampere turns per pole.

Hence full load field ampere turns per pole can be assumed 1.7 to 2.0 times the armature ampere turns per pole.

Armature ampere turns per pole $AT_a = 1.35 I_{ph} T_{ph} K_w / p$

And

$$AT_{fl} = (1.7 \text{ to } 2.0) AT_a$$

Height of the pole is calculated based on the height of the filed coil required and the insulation.

Height of the filed coil:

I_f = current in the field coil

a_f = area of the field conductor

T_f = number of turns in the field coil

R_f = resistance of the field coil

l_{mt} = length of the mean turn of the field coil

s_f = copper space factor

h_f = height of the field coil

d_f = depth of the field coil

p_f = permissible loss per m^2 of the cooling surface of the field coil

ζ = specific resistance of copper

Watts radiated from the field coil = External surface in cm^2 x watts/ cm^2
= External periphery of the field coil x Height of the field coil x watts/ cm^2

Total loss in the coil = $(I_f^2 \times R_f) = (I_f^2 \times \zeta \times l_{mt} \times T_f / a_f)$

Total copper area in the field coil = $a_f \times T_f = s_f h_f d_f$

Hence $a_f = s_f d_f h_f / T_f$

Thus watts lost per coil = $(I_f^2 \times \zeta \times l_{mt} \times T_f) T_f / s_f h_f d_f$

$$= (I_f T_f)^2 \zeta \times l_{mt} / s_f h_f d_f$$

Loss dissipated from the field coil = q_f x cooling surface of the field coil

Normally inner and outer surface of the coils are effective in dissipating the heat. The heat dissipated from the top and bottom surfaces are negligible.

Cooling surface of the field coil = $2 \times l_{mt} \times h_f$

Hence loss dissipated from the field coil = $2 \times l_{mt} \times h_f \times q_f$

For the temperature rise to be within limitations

Watts lost per coil = watts radiated from the coil

$$(I_f T_f)^2 \zeta \times l_{mt} / s_f h_f d_f = 2 \times l_{mt} \times h_f \times q_f$$

$$\begin{aligned} \text{Hence } h_f &= (I_f T_f) / [10^4 \times \sqrt{(s_f d_f q_f)}] \\ &= AT_{fl} \times 10^{-4} / \sqrt{(s_f d_f q_f)} \end{aligned}$$

Depth of the field coil is assumed from 3 to 5 cm,

Copper space factor may be assumed as 0.6 to 0.8,

Loss per m^2 may be assumed as 700 to 750 w/m^2

Hence the height of the pole = h_f + height of the pole shoe + height taken by insulation

Design of field winding for salient pole Alternator:

Design of the field winding is to obtain the following information.

- (i) Cross sectional area of the conductor of field winding
- (ii) Current in field winding

- (iii) Number of turns in field winding
- (iv) Arrangement of turns
- (v) Resistance of the field winding
- (vi) Copper loss in the field winding

Above informations can be obtained following the following steps

- (i) Generally the exciter voltage will be in the range of 110 volts to 440 volts. 15-20 % of voltage is kept as drop across the field controller.
Hence voltage per coil $V_c = (0.8 \text{ to } 0.85) \text{ exciter voltage} / \text{Number of field coils}$
- (ii) Assume suitable value for the depth of the field coil
- (iii) Mean length of the turn in field coil is estimated from the dimensions of the pole and the depth of the field windings. Mean length of the turn $= 2(l_p + b_p) + \pi(d_f + 2t_i)$ where t_i is the thickness of insulation on the pole.
- (iv) Sectional area of the conductor can be calculated as follows

Resistance of the field coil $R_f = \zeta \times l_{mt} \times T_f / a_f = \text{voltage across the coil} / \text{field coil}$

$$V_c / I_f = \zeta \times l_{mt} \times T_f / a_f$$

$$\text{Hence } a_f = \zeta \times l_{mt} \times I_f T_f / V_c$$

- (v) Field current can be estimated by assuming a suitable value of current density in the field winding. Generally the value of current density may be taken as 3.5 to 4 amp/mm².
Hence $I_f = \delta_f \times a_f$
- (vi) Number of turns in the field winding $T_f = \text{Full load field ampere turns} / \text{field current} = AT_{fl} / I_f$
- (vii) Height of the field winding $h_f = AT_{fl} \times 10^{-4} / \sqrt{(s_f d_f q_f)}$
- (viii) Resistance of the field winding $R_f = \zeta \times l_{mt} \times T_f / a_f$
- (ix) Copper loss in the field winding $= I_f^2 \times R_f$

Numerical Problems on Field System Design of Salient pole machines:

Ex.1. The following information has been obtained during the preliminary design of a 3 phase 500 kVA, 6.6 kV, 12 pole, 500 rpm, star connected salient pole alternator.

Stator diameter = 1.3 m, gross length of stator = 0.21m, air gap flux per pole = 0.0404 wb

Based on the above information, design the field system of the alternator giving the following details.

- (i) Length of the air gap
- (ii) Diameter of the rotor at the air gap surface
- (iii) Dimension of the pole

Soln:

$$\begin{aligned} \text{(i) Length of the air gap : Air gap flux per pole} &= B_{av} \times \pi DL/p \\ &= (12 \times 0.0404) / (\pi \times 1.3 \times 0.21) \\ &= 0.56 \text{ Tesla} \end{aligned}$$

$$\text{We have } AT_{f0} = SCR \times AT_a \text{ and } AT_a = 1.35 I_{ph} T_{ph} K_w / p$$

$$\text{We have } E_{ph} = 4.44 f \Phi T_{ph} k_w \text{ and}$$

$$\text{Hence } T_{ph} \times K_w = E_{ph} / (4.44 f \Phi) = 6600 / \sqrt{3} / (4.44 \times 50 \times 0.0404) = 424$$

$$\text{Full load current} = 500 \times 10^3 / \sqrt{3} \times 6600 = 43.7 \text{ amps}$$

$$AT_a = 1.35 I_{ph} T_{ph} K_w / p = 1.35 \times 43.7 \times 424 / 6 = 4169 \text{ AT}$$

$$\text{Assuming a short circuit ratio of 1.1 } AT_{f0} = SCR \times AT_a = 1.1 \times 4169 = 4586 \text{ AT}$$

Assuming AT required for the air gap as 70 % of the no load field ampere turns per pole

$$AT_g = 0.7 \times AT_{f0} = 0.7 \times 4586 = 3210 \text{ AT}$$

Assuming Carter's coefficient for the air gap k_g as 1.15 and field form factor K_f as 0.7

$$B_g = B_{av} / K_f = 0.56 / 0.7 = 0.8 \text{ Tesla}$$

$$\text{We have air gap ampere turns } AT_g = 796000 B_g k_g l_g$$

$$\text{Hence air gap length } l_g = 3210 / (796000 \times 0.8 \times 1.15) = 0.0044 \text{ m} = 4.4 \text{ mm}$$

$$(ii) \text{ Diameter of the rotor } D_r = D - 2 l_g = 1.2 - 2 \times 0.0044 = 1.191 \text{ m}$$

$$(iv) \text{ Peripheral speed} = \pi D_r N_s / 60 = \pi \times 1.191 \times 500 / 60 = 31.2 \text{ m/s}$$

(v) Dimensions of the pole : Assuming the axial length as 1 cm less than that of the gross length of the stator

$$(a) \text{ Axial length of the pole } L_p = 0.21 - 0.01 = 0.2 \text{ m}$$

(b) Width of the pole: Assuming the leakage factor for the pole as 1.15

$$\text{Flux in the pole body } \Phi_p = 1.15 \times 0.0404 = 0.0465 \text{ wb}$$

Assuming flux density in the pole body as 1.5 Tesla

$$\text{Area of the pole} = 0.0465 / 1.5 = 0.031 \text{ m}^2$$

Assuming a stacking factor of 0.95

$$\text{Width of the pole} = \text{area of the pole} / \text{stacking factor} \times L_p = 0.031 / (0.95 \times 0.2) = 0.16 \text{ m}$$

$$\text{Height of the pole: Assuming } AT_{fl} = 1.8 \times AT_a = 1.8 \times 4169 = 7504 \text{ AT}$$

Assuming : Depth of the field coil = 4 cm

$$\text{Space factor for the filed coil} = 0.7$$

$$\text{Permissible loss per unit area} = 700 \text{ w/m}^2$$

$$\begin{aligned} \text{Height of the filed coil } h_f &= (I_f T_f) / [10^4 \times \sqrt{(s_f d_f q_f)}] \\ &= 7504 / [10^4 \times \sqrt{(0.04 \times 0.7 \times 700)}] \\ &= 0.17 \text{ m} \end{aligned}$$

Hence the height of the pole = h_f + height of the pole shoe + height taken by insulation

Assuming height of the pole shoe + height taken by insulation as 0.04 m

$$\text{Height of the pole} = 0.17 + 0.04 = 0.21 \text{ m}$$

Ex.2. The field coils of a salient pole alternator are wound with a single layer winding of bare copper strip 30 mm deep, with a separating insulation of 0.15 mm thick. Determine a suitable winding length, number of turns and thickness of the conductor to develop an mmf of 12000 AT with a potential difference of 5 volts per coil and with a loss of 1200 w/m² of total coil surface. The mean length of the turn is 1.2 m. The resistivity of copper is 0.021 Ω/m and mm².

$$\begin{aligned} \text{Soln. Area of field conductor } a_f &= \zeta \times (I_f T_f) / V_c \\ &= 0.021 \times 1.2 \times 12000 / 5 \\ &= 60.4 \text{ mm}^2 \end{aligned}$$

$$\text{Hence height of the conductor} = 60.4 / 30 = 2 \text{ mm}$$

$$\text{Revised area of the conductor} = 60 \text{ mm}^2$$

$$\begin{aligned} \text{Total heat dissipating surface } S &= 2 \times l_{mt} (h_f + d_f) \\ &= 2 \times 1.2 (h_f + 0.03) \\ &= 2.4 h_f + 0.072 \text{ m}^2 \end{aligned}$$

Hence total loss dissipated $Q_f = 1200 (2.4 h_f + 0.072)$ watts
 $= 2880 h_f + 86.4$ watts

Field current $I_f = Q_f / V_c = (2880 h_f + 86.4) / 5 = 5.76 h_f + 17.3$

And $I_f T_f = (5.76 h_f + 17.3) T_f = 12000$

$I_f T_f = 5.76 h_f T_f + 17.3 T_f = 12000$

Height occupied by the conductor including insulation $= 2 + 0.15 = 2.15$ mm

Hence height of the field winding $h_f = T_f \times 2.15 \times 10^{-3}$

Substituting this value in the expression for $I_f T_f$ we get

$$I_f T_f = 5.76 \times T_f \times 2.15 \times 10^{-3} T_f + 17.3 T_f = 12000$$

$$\text{Solving for } T_f, T_f = 91$$

Hence height of the field winding $= 2.15 \times 91 = 196$ mm

Ex. 3 Design the field coil of a 3 phase, 16 pole, 50 Hz, salient pole alternator, based on the following design information. Diameter of the stator = 1.0 m, gross length of the stator = 0.3 m, section of the pole body = 0.15 m x 0.3 m, height of the pole = 0.15 m, Ampere turns per pole = 6500, exciter voltage = 110 volts, Assume missing data suitably.

Soln. Sectional area of the conductor:

Assuming 30 volts as reserve in field regulator

$$V_c = 110 - 30 / 16 = 5 \text{ volts}$$

Assuming depth of the field coil = 3 cm, thickness of insulation = 1 cm

Mean length of the turn $= 2(l_p + b_p) + \pi(d_f + 2t_i) = 2(0.3 + 0.15) + \pi(0.03 + 2 \times 0.01) = 1.05$ m

$$\text{Sectional area of the conductor } a_f = \zeta \times l_{mt} \times I_f T_f / V_c$$

$$= (0.021 \times 1.05 \times 6000) / 5 = 28.66 \text{ mm}^2$$

Standard size of the conductor available = 28.5 mm² with the size 16 mm x 1.8 mm

Assuming an insulation thickness of 0.5 mm over the conductor

size of the conductor = 16.5 mm x 2.3 mm

Assuming an insulation of 2mm between the layers

Actual depth of the field winding $= 16.5 + 2 + 16.5 = 35$ mm or 3.5 cm

Field current: Assuming a current density of 2.6 amps/ mm²

$$\text{Field current } I_f = a_f \times \delta_f = 28.5 \times 2.6 = 74 \text{ amps}$$

Number of turns: $T_f = I_f T_f / I_f = 6000 / 74 = 88$ turns

Arrangement of turns: As decided above 88 turns are arranged in two layers with 44 turns in each layer. Height of each field turn = 2.3 mm

Hence height of the field coil $= 44 \times 2.3 = 10.1$ cm

As height of the pole is 15 cm, height of the field coil is satisfactory.

$$\text{Resistance of the field coil } R_f = \zeta \times l_{mt} \times T_f / a_f$$

$$= 0.021 \times 1.05 \times 88 / 28.5$$

$$= 0.068 \Omega$$

Filed Copper loss: $I_f^2 R_f = 74^2 \times 0.068 = 372$ watts

Total field cu loss $= 16 \times 372 = 5.95$ kW.

Ex.4. Design the field coil of a 500 rpm, 3 phase, 50 Hz alternator having the following design data.

Diameter of stator = 95 cm, Core length = 30 cm, Pole body = 10 cm x 30 cm, Field ampere turns = 6000, Excitation voltage = 80 volts. Heat dissipation from the outer surface = 0.35 watts/ cm². Assume missing data suitably.

Soln: Area of the field coil:

Number of field coils or poles = $120f/N_s = 120 \times 50 / 500 = 12$

Assuming 20 volts in the field regulator

Voltage per coil = $80 - 20 / 12 = 5$ volts

Ampere turns /pole = 6000

Pole body = 10 cm x 30 cm,

Assuming depth of the field coil = 3 cm,

Thickness of insulation = 1 cm

Mean length of the turn = $2(l_p + b_p) + \pi(d_f + 2t_i)$
 $= 2(0.3 + 0.1) + \pi(0.03 + 2 \times 0.01) = 0.957$ m

Sectional area of the conductor $a_f = \zeta \times l_{mt} \times I_f T_f / V_c$
 $= (0.021 \times 0.957 \times 6000) / 5 = 24.2$ mm²

Standard size of the conductor available 14.2 mm x 1.7 mm

Assuming an insulation thickness of 0.5 mm over the conductor

Assuming an insulation of 1.6 mm between the layers

Actual depth of the field winding = $14.2 + 1.6 + 14.2 = 3.0$ cm

Number of turns: Heat dissipation from the outer surface = 0.35 watts/cm²

Area of the outer surface of the field coil = $(l_{mt} + \pi d_f) h_f = (95.7 + \pi \times 3) h_f$
 $= 105.1 h_f$ cm²

Hence heat dissipated = $0.35 \times 105.1 h_f = 36.8 h_f = V_c \times I_f$
 $= V_c \times I_f T_f / T_f$

Hence $36.8 h_f = V_c \times I_f T_f / T_f$
 $= 5 \times 6000 / T_f$

Hence $h_f T_f = 5 \times 6000 / 36.8 = 815$

Assuming an insulation thickness of 0.15 mm between the conductors

Height of each conductor = Height of conductor + insulation
 $= 1.7 + 0.15 = 1.85$ mm = 0.185 cm

Assuming that the turns are arranged in two layers

Height of turns / layer $h_f = 0.185 \times T_f / 2$

Hence $h_f T_f = 0.185 \times T_f / 2 \times T_f = 815$
 $T_f = 94$

Hence height of the field coil $h_f = 0.185 \times T_f / 2 = 0.185 \times 94 / 2 = 8.7$ cm

Field current $I_f = 6000 / 94 = 64$ amps

Resistance of the field coil $R_f = \zeta \times l_{mt} \times T_f / a_f$
 $= 0.021 \times 0.957 \times 94 / 24.2$
 $= 0.078$ Ω

Filed Copper loss: $I_f^2 R_f = 64^2 \times 0.078 = 320$ watts

Total field cu loss = $12 \times 320 = 3.84$ kW.

Design of the field System: NonSalient pole Alternator:

In case of turbo alternators, the rotor windings or the field windings are distributed in the rotor slots. The rotor construction of the turbo alternator is as shown in fig. below.

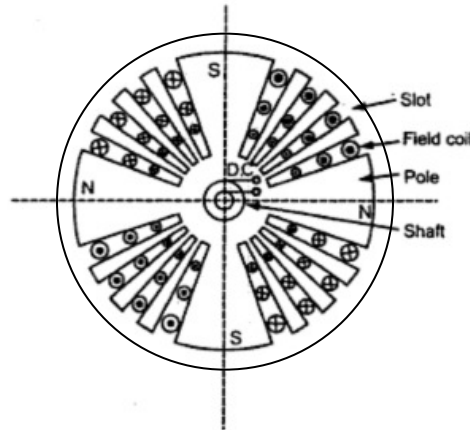

Normally 70% of the rotor is slotted and remaining portion is unslotted in order to form the pole. The design of the field can be explained as follows.

(i) Selection of rotor slots: Total number of rotor slots may be assumed as 50 – 70 % of stator slots pitches. However the so found rotor slots must satisfy the following conditions in order to avoid the undesirable effects of harmonics in the flux density wave forms.

- (a) There should be no common factor between the number of rotor slot pitches and number of stator slot pitches.
- (b) Number of wound rotor slots should be divisible by 4 for a 2 pole synchronous machine. That means the number of rotor slots must be multiple of 4.
- (c) Width of the rotor slot is limited by the stresses developed at the rotor teeth and end rings.

(ii) Design of rotor winding

(a) Full load field mmf can be taken as twice the armature mmf.

$$AT_{fl} = 2 \times AT_a = 2 \times 1.35 \times I_{ph} \times T_{ph} \times k_w / p$$

(b) Standard exciter voltage of 110 - 220 volts may be taken. With 15-20 % of this may be reserved for field control. Hence voltage across each field coil $V_f = (0.8 \text{ to } 0.85) V/p$

(c) Length of the mean turn $l_{mt} = 2L + 1.8 \tau_p + 0.25 \text{ m}$

(d) Sectional area of each conductor $a_f = \zeta \times l_{mt} \times (I_f \times T_f) / v_f$

(e) Assume suitable value of current density in the rotor winding. 2.5 – 3.0 amp/mm² for conventionally cooled machines and 8 – 12 amp/mm² for large and special cooled machines.

(f) Find area of all the rotor conductors per pole = $2 \times (I_f \times T_f) / \delta_f$

(g) Find the number of rotor conductors per pole = $2 \times (I_f \times T_f) / (\delta_f \times a_f)$

(h) Number of field conductors per slot = $2 \times (I_f \times T_f) / (\delta_f \times a_f \times s_r)$, where s_r is the number of rotor slots.

(i) Resistance of each field coil $R_f = \zeta \times l_{mt} \times T_f / a_f$

(j) Calculate the current in the field coil $I_f = v_f / R_f$

Based on the above data dimensions may be fixed. The ratio of slot depth to slot width may be taken between 4 and 5. Enough insulation has to be provided such that it with stands large amount of mechanical stress and the forces coming on the rotor.

The following insulation may be provided for the field coil.

(i) All field conductors are provided with mica tape insulation.

- (ii) Various turns in the slots are separated from each other by 0.3 mm mica separators.
- (iii) 0.5 mm hard mica cell is provided on all the field coil.
- (iv) Over the above insulation, 1.5 mm flexible mica insulation is provided.
- (v) Lastly a steel cell of 0.6 mm is provided on the whole field coil.

Ex. 1. Design the rotor of a 3 phase 20 MVA, 11 kV, 3000 rpm, 50 Hz, turbo alternator with the following design data. Diameter at the air gap = 0.8 m, Gross length = 2.4 m, stator turns per phase = 18, Number of stator slots = 36, Exciter voltage = 220 volts, Estimate (i) Number of rotor slots, (ii) area of the field conductor (iii) Turns in the filed coil and (iv) Field current

Soln: (i) Number of rotor slots : Selection of rotor slots: Total number of rotor slots may be assumed as 50 – 70 % of stator slots. Normally 70% of the rotor is slotted and remaining portion is unslotted.

Number of stator slots = 36

Hence number of slots pitches must be between 18 to 26

Satisfying the conditions number of rotor slot pitches = 23

Number of wound slots = 16

(ii) Area of the field conductor

Assuming 40 volts in the field regulator voltage across filed coil = $220 - 40 / 2 = 90$ volts

Armature ampere turns /pole $AT_a = 1.35 I_{ph} T_{ph} K_w / p$

$$= 1.35 \times 1050 \times 18 \times 0.955 / 1 = 24300 \text{ AT}$$

Assuming full load field ampere turns/pole = $2 \times AT_a = 2 \times 24300 = 48600 \text{ AT}$

Mean length of the turn is given by $l_{mt} = 2L + 1.8 \tau_p + 0.25 \text{ m}$

$$= 2 \times 2.4 + 1.8 \times 1.256 + 0.25$$

$$= 7.31 \text{ m}$$

Area of the field conductor $a_f = \zeta \times l_{mt} \times (I_f \times T_f) / v_f$

$$= 0.021 \times 7.31 \times 48600 / 90$$

$$= 83.22 \text{ mm}^2$$

(iii) Number of field turns : Full load field ampere turns/pole = 48600 AT

Full load field ampere conductors/pole = $2 \times 48600 \text{ AT}$

Assuming a current density of 2.6 amp/mm^2

Area of all the rotor conductors = $2 \times 48600 / 2.6 = 37400 \text{ mm}^2$

Number of rotor conductors/pole = $37400 / 84 = 445$

Number of wound slots per pole = $16 / 2 = 8$

Number of conductors per slot = $445 / 8 = 56$

Modified value of conductors per pole = $56 \times 8 = 448$

Number of field turns per pole $T_f = 448 / 2 = 224$

Number of coils per pole = $8 / 2 = 4$

(iv) Field current: Resistance of the field coil $R_f = \zeta \times l_{mt} \times T_f / a_f$

$$= 0.021 \times 7.31 \times 224 / 84$$

$$= 0.41 \Omega$$

Current in the field winding $I_f = V_c / R_f = 90 / 0.41 = 219 \text{ Amps}$.

References

1. A Course in Electrical Machine Design – A. K. Sawhney
2. Design of Electrical Machines – V. N. Mittle
3. Performance and Design of A C Machines – M G Say
4. Design and Testing of Electrical Machines – M. V. Deshapande
5. Electrical Machine Design Data Book – Shanmugsundaram and Palani
6. www.google.com and related websites
7. www.phasemotorparts.com
8. www.wikipedia.org
9. Krishna Vasudevan et. al. Electrical Machines II, Indian Institute of Technology, Madras